



Catalytic Flammable Gas Sensor

(**Model:** ZC2521-A)

User's Manual

Version: 1.3B

Valid from: 2021-7-16

Taiyuan Tengxing sensor technology Co., Ltd

Statement

1.The copyright of instructions belong to Taiyuan Tengxing sensor technology Co., Ltd(hereinafter referred to as the Company), nobody is allowed to copy, translate, spread or store without written approval.

2.Thanks for using our product. In order to use the products more smoothly, reduce faults result from inappropriate using, please read the instructions carefully before using and follow the rules suggested strictly. Anyone who don ' t follow the instructions, disassemble or change the internal components without permission will afford the loss.

3.The color, style and size of the product is subject to the object you received.

4.The company follows the idea of scientific and technological progress, make efforts to product-improving and technology-innovating. So we have the right to improve product without prior notice.

5.Please make sure it ' s valid before using the instructions. Any good suggestions from you is welcomed.

6.The instructions should be well kept.

Taiyuan Tengxing sensor technology Co., Ltd

ZC2521-A Catalytic Flammable Gas Sensor

Product

ZC2521-A adopts catalytic combustion principle, and its two arms of electric bridge consists of a test element and a compensate element. The resistance of the test element rises once it meets the combustible gases, in the same time, the output voltage of the bridge changes and the voltage variation rises in direct proportion to the gas concentration. The compensate element, as a conference, has the function of compensating temperature and humidity.

Features

Bridge output voltage in linear

Fast response

Good repeatability and selectivity

Resist H₂S poisoning & organosilicone.

Main Applications

It is widely used in non-industrial occasions to detect the concentration of natural gas, LPG, coal gas and alkanes.

It is also used in combustible gas leakage alarm system, combustible gas detector and gas concentration meter and so on.

Parameters:

Model	ZC2521-A	
Sensor Type	Catalytic Type	
Standard Encapsulation	Plastic	
Working voltage(V)	2.5 ± 0.1	
Working current(mA)	150 ± 10	
Sensitivity (mV)	1% CH ₄	20 ~ 50
	1% C ₃ H ₈	30 ~ 70
Linearity	≤ 5%	
Measuring range(%LEL)	0 ~ 100	
Response Time (90%)	≤ 10s	
Recovery Time (90%)	≤ 30s	
Working Environment	-10 ~ +55 °C < 95%RH	
Storage Environment	-25 ~ +70 °C < 95%RH	
Lifespan	5 years	

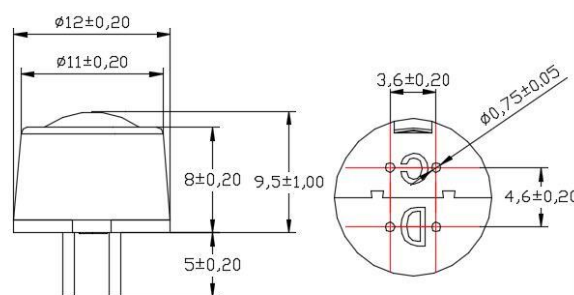

Fig1. Sensor Structure

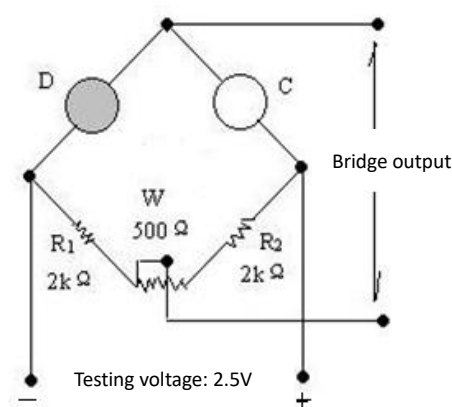

Fig2. Basic Test Circuit

Sensitivity and Response Feature

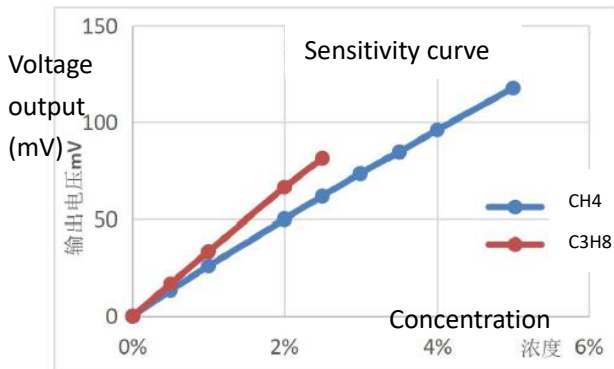

Fig3. Sensitivity Curve

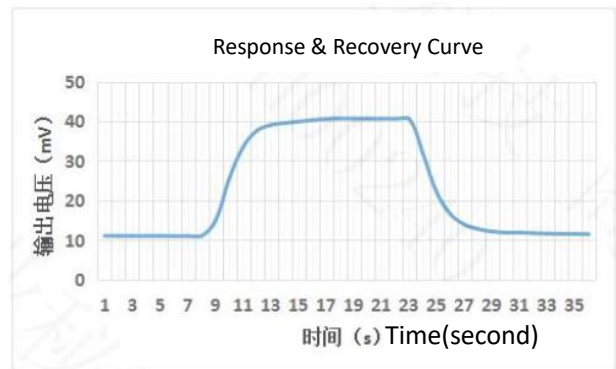

Fig4. Response and recovery

Changing of output signal at different temperature

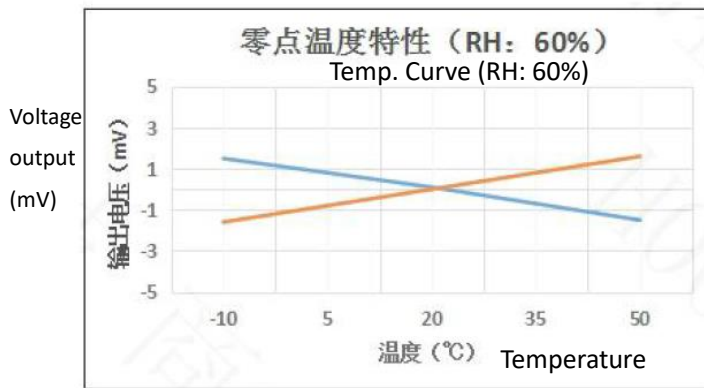

Fig5. Zero point at different temp.

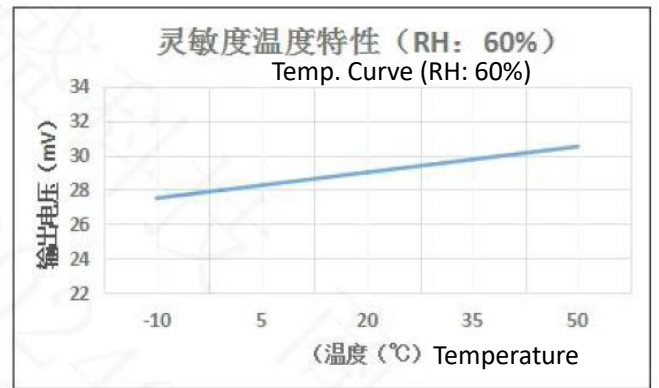

Fig6. Sensitivity at different temp.

Changing of output signal at different humidity

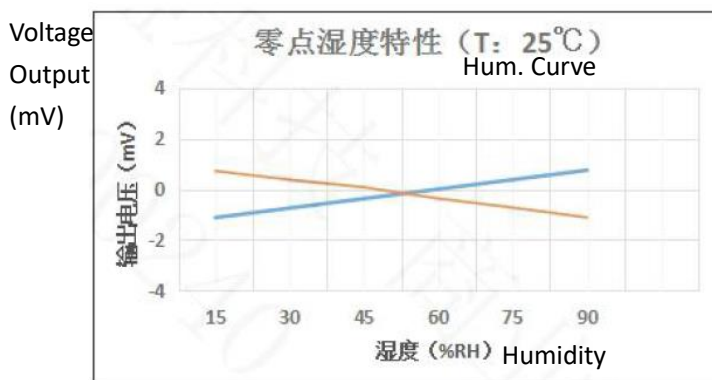

Fig7. Zero point at different humidity

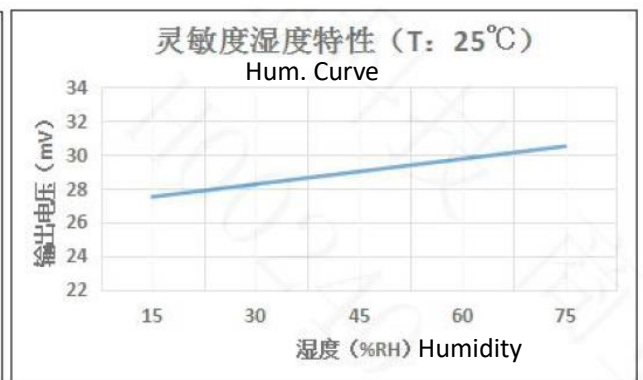

Fig8. Sensitivity at different humidity

Changing of output signal with different voltage supplying

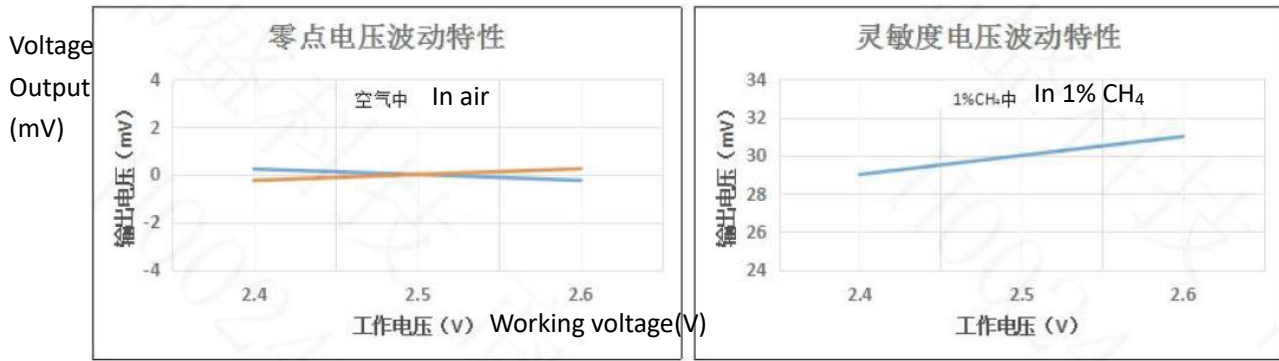

Fig9.Zero Drift with different voltage

Fig10.Sensitivity with different voltage

Long-term Stability

The drift in air per year is within $\pm 2\text{mV}$, in 1%CH₄ is within $\pm 2\text{mV}$. For a short period storage (in 2 weeks), the sensor need be galvanical continuously for 8 hours to reach stability. For long period storage (one year), it need 48 hours.

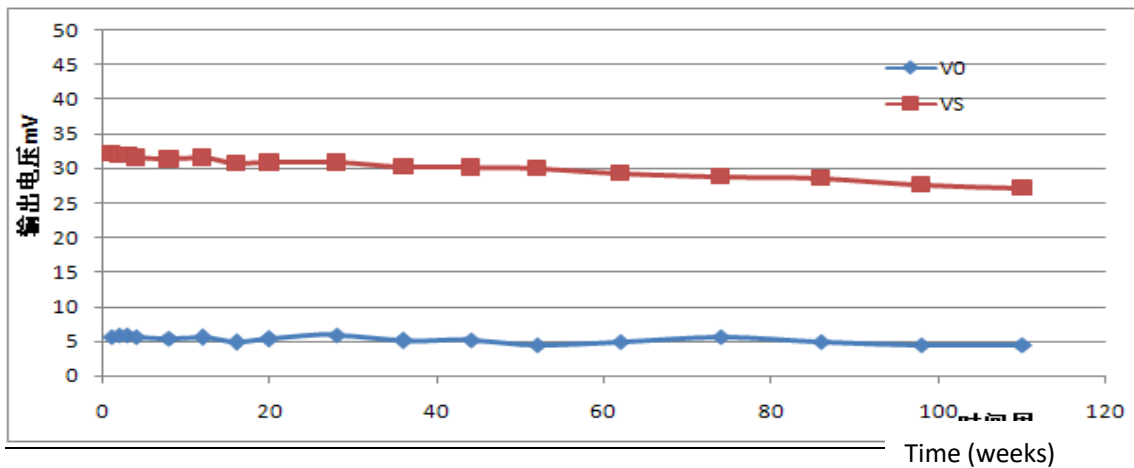

Fig11. Zero and Sensitivity stability curve

Cautions

1 .Following conditions must be prohibited

1.1 Exposed to organic silicon steam

Sensing material will lose sensitivity and never recover if the sensor absorbs organic silicon steam. Sensors must avoid exposing to silicon bond, fixture, silicon latex, putty or plastic contain silicon environment.

1.2 High Corrosive gas

If the sensors are exposed to high concentration corrosive gas (such as H₂S, SO_x, Cl₂, HCl etc.), it will not only result in corrosion of sensors structure, also it cause sincere sensitivity attenuation.

1.3 Alkali, Alkali metals salt, halogen pollution

The sensors performance will be changed badly if sensors be sprayed polluted by alkali metals salt especially brine, or be exposed to halogen such as fluorine.

1.4 Touch water

Sensitivity of the sensors will be reduced when spattered or dipped in water.

1.5 Freezing

Do avoid icing on sensor's surface, otherwise sensing material will be broken and lost sensitivity.

1.6 Applied high voltage

Applied voltage on sensor should not be higher than stipulated value, even if the sensor is not physically damaged or broken, it causes down-line or heater damaged, and bring on sensors' sensitivity characteristic changed badly.

1.7 Pins connection

When the sensor is connecting to the circuit, one of detection part pins and one of compensation part pins connects as the signal output. The other pin of detection part connects negative electrode, while the other pin of compensation part connects positive electrode. The part with "D" mark on the sensor bottom is the detection one, the other part with "C" mark is the compensation one.

2 .Following conditions must be avoided

2.1 Water Condensation

Indoor conditions, slight water condensation will influence sensors' performance lightly. However, if water condensation on sensors surface and keep a certain period, sensors' sensitive will be decreased.

2.2 Used in high gas concentration

No matter the sensor is electrified or not, if it is placed in high gas concentration for long time, sensors characteristic will be affected. If lighter gas sprays the sensor, it will cause extremely damage.

2.3 Long time storage

The sensors resistance will drift reversibly if it's stored for long time without electrify, this drift is related with storage conditions. Sensors should be stored in airproof bag without volatile silicon compound. For the sensors with long time storage but no electrify, they need long galvanical aging time for stability before using. The suggested aging time is 24 hours at least if the storage time is more than half an year.

2.4 Long time exposed to adverse environment

No matter the sensors electrified or not, if exposed to adverse environment for long time, such as high humidity, high temperature, or high pollution etc., it will influence the sensors' performance badly.

2.5 Vibration

Continual vibration will result in sensors down-lead response then break. In transportation or assembling line, pneumatic screwdriver/ultrasonic welding machine can lead this vibration.

2.6 Concussion

If sensors meet strong concussion, it may lead its lead wire disconnected.

2.7 Usage Conditions

For sensor, handmade welding is optimal way. The welding conditions as follow:

- Soldering flux: Rosin soldering flux contains least chlorine
- Homothermal soldering iron
- Temperature: <math><350^{\circ}\text{C}</math>
- Time: less than 5 seconds

If disobey the above using terms, sensors performance will get worse.
